

Communication Module M 700[®] FF 700(X)

Communication Unit
for FOUNDATION FIELDBUS[™]



METTLER TOLEDO



71963

Warranty

Defects occurring within 1 year from delivery date shall be remedied free of charge at our plant (carriage and insurance paid by sender). Sensors, fittings, and accessories: 1 year.

©2007 Subject to change without notice

Return of products under warranty

Please contact our Service Team before returning a defective device. Ship the cleaned device to the address you have been given. If the device has been in contact with process fluids, it must be decontaminated/disinfected before shipment. In that case, please attach a corresponding certificate, for the health and safety of our service personnel.

Disposal

Please observe the applicable local or national regulations concerning the disposal of "waste electrical and electronic equipment".

Trademarks

The following registered trademarks are used in this instruction manual without further marking

SMARTMEDIA®

is a registered trademark of Toshiba Corp., Japan

FOUNDATION FIELDBUS™

is a trademark of Fieldbus Foundation, Austin, USA

Mettler-Toledo AG,
Process Analytics, Industrie Nord, CH-8902 Urdorf,
Tel. +41 (44) 729 62 11 Fax +41 (44) 729 26 36
Subject to technical changes.





FOUNDATION

FIELDBUS FOUNDATION DEVICE REGISTRATION

Presented To: Mettler Toledo GmbH, Process Analytics
Model: M700 FF700
Device Type: Measuring System for Liquid Analysis
ITK_Ver: 4.61
IT Campaign Number: IT039100
Registration Date: 7/19/2006
DD Revision: 0x01
CFF Revision: 010101.cff

The above device has successfully completed rigorous testing by the Fieldbus Foundation and has received registration and the right to use the checkmark logo as specified by MT-045.



Heather Santos
Product Support Specialist

Richard Timoney
President

Contents

Modul M 700 FF 700(X)

Warranty	2
Disposal	2
Trademarks	2
Intended Use	6
Conformity with FDA 21 CFR Part 11	6
Safety Information	7
Application in Hazardous Locations: FF 700 X Module	7
Software Version	8
Modular Concept	9
Short Description.....	10
Short Description: FRONT Module.....	10
Short Description: Menu Structure.....	11
Short Description: BASE Module.....	13
Foundation Fieldbus (FF) Technology	14
Bus Communication.....	15
Terminal Plate	16
Mise en place du module.....	17
Foundation Fieldbus Installation	19
Communication Model	21
Resource Block (RB)	21
Analog Input Block (AI).....	21
Analog Input Transducer Block (AI TB)	21
Connections (Channels).....	21
AI-TB Configuration on the Device.....	22
AI-TB Configuration on the Device.....	23
Bus activation	23
For Copy: Individual Settings	24
Offline Configuration.....	25
Initial Commissioning.....	27
Analog Input blocks.....	28
Configuration of AI TB.....	29
Configuration with Foundation Fieldbus	30
Commissioning on the Foundation Fieldbus.....	30

Contents

Modul M 700 FF 700(X)

Commissioning and Configuration.....	31
Calibration Protocols.....	35
Parameters of AI Transducer Blocks.....	36
Function Block AO.....	37
DI Function Blocks.....	38
DI 1: EC 400 Status.....	38
DI 2: CONTACTS / LOCK Status / ENABLE Request.....	38
DI 3: EC 400 Messages.....	39
Explanation of EC 400 Messages: Maintenance request.....	39
Explanation of EC 400 Messages: Failure.....	40
DI 4: EC 400 Step.....	40
DO Function Blocks.....	41
DO 1: HOLD Control.....	41
DO 2: PARSET.....	41
DO 3: EC 400 Control.....	42
DO 4: LOCK Control.....	42
Enable / Lock via DCS.....	43
Menu Selection.....	44
Passcode Entry.....	45
Function Control Matrix.....	46
Specifications.....	47
Process Variables (Fieldbus).....	49
Module Types pH:.....	49
Calculation Block pH / pH.....	49
Module Types O ₂ :.....	50
Calculation Block O ₂ / O ₂	50
Module Types Cond:.....	51
Calculation Block Cond / Cond.....	51
Module Types Cond Ind:.....	52
Calculation Block Cond Ind / Cond Ind.....	52
Process Variables (Fieldbus).....	53
Module Types CO ₂ :.....	53
Calculation Block pH / pH.....	53
Index.....	54

Intended Use

The module is a communication unit for Foundation Fieldbus and allows digital communication via current modulation.

The FF 700 X module is intended for operation in locations subject to explosion hazards which require equipment of Group II, device category 2(1), gas/dust.

Conformity with FDA 21 CFR Part 11

In their directive "Title 21 Code of Federal Regulations, 21 CFR Part 11, Electronic Records; Electronic Signatures" the US American health agency FDA (Food and Drug Administration) regulates the production and processing of electronic documents for pharmaceutical development and production. This results in requirements for measuring devices used for corresponding applications. The following features ensure that the M 700(X) modular process analysis system meets the demands of FDA 21 CFR Part 11:

Electronic Signature

Access to the device functions is regulated and limited by individually adjustable codes – "Passcodes". This prevents unauthorized modification of device settings or manipulation of the measurement results. Appropriate use of these passcodes makes them suitable as electronic signature.

Audit Trail Log

Every change of device settings can be automatically recorded and documented in the Audit Trail Log on the SmartMedia card. The recording can be encrypted.

Safety Information

Application in Hazardous Locations

Caution!

Never try to open the module! If a repair should be required, return the module to our factory.

If the specifications in the instruction manual are not sufficient for assessing the safety of operation, please contact the manufacturer to make sure that your intended application is possible and safe.

Be sure to observe during installation:

- Switch off power supply before replacing or inserting a module.
- Before commissioning it must be proved that the device may be connected with other equipment.

Application in Hazardous Locations:

FF 700 X Module

When using the FF 700 X module, the stipulations for electrical installations in hazardous areas (EN 60079-14) must be observed. When installing the device outside the range of applicability of the 94/9/EC directive, the appropriate standards and regulations in the country of use must be observed. The module has been developed and manufactured in compliance with the applicable European guidelines and standards.

Compliance with the European Harmonized Standards for use in hazardous locations is confirmed by the EC-Type-Examination Certificate. Compliance with the European guidelines and standards is confirmed by the EC Declaration of Conformity.

There is no particular direct hazard caused by the operation of the device in the specified environment.

Software Version

FF 700(X) Module

Device Software M 700(X)

The FF 700(X) module is supported by software version 7.0 or higher.

Module Software FF 700(X)

Software version 1.0 18.09.2006

Query actual device/module software

When the analyzer is in measuring mode:
Press **menu** key, open Diagnostics menu.

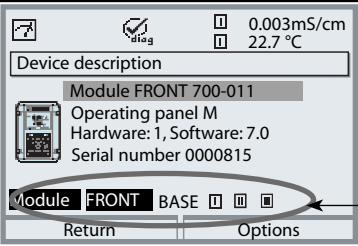
Menu	Display	Device description
 diag		Provides information about all modules installed: Module type and function, serial number, hardware and software version and device options. Select the different modules (FRONT, BASE, slots 1 - 3) using the arrow keys.

Modular Concept

Basic Unit, Measuring Module, Additional Functions

The M 700(X) is an expandable modular process analysis system. The basic unit (FRONT and BASE modules) provides three slots which can be equipped by the user with any combination of measuring or communication modules. The software capabilities can be expanded by additional functions (options). Additional functions must be ordered separately. They are supplied with a device-specific TAN for function release.

M 700(X) Modular Process Analysis System



Additional functions

Activation via device-specific TAN



SmartMedia card

Data recording



3 module slots

for free combination of measuring and communication modules

Measuring modules

- pH / ORP / Temp
- O₂/Temp
- Noncontacting conductivity/Temp
- Contacting conductivity/Temp

Communication modules

- OUT (additional switching and current outputs)
- PID (analog and digital controller)
- Profibus PA
- Foundation Fieldbus
- EC 400 probe controller

Documentation

The basic unit is accompanied by a CD-ROM containing the complete documentation.

Latest product information as well as instruction manuals for earlier software releases are available at www.mtpro.com.

Short Description

Short Description: FRONT Module

4 captive screws

for opening the analyzer

(Caution! Make sure that the gasket between FRONT and BASE is properly seated and clean!)

Transflective LC graphic display

(240 x 160 pixels)

white backlighting, high resolution and high contrast.

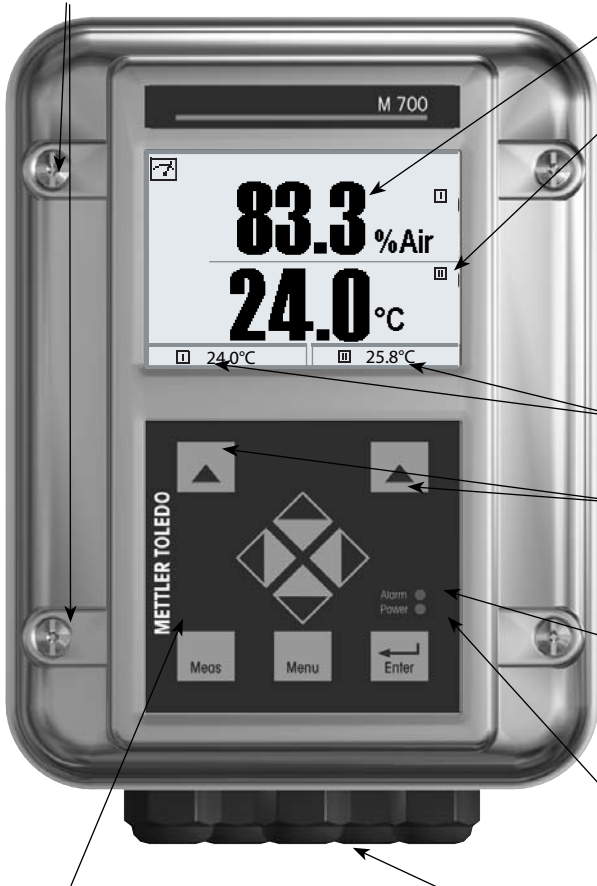

Measurement display

User interface

with plaintext menus as recommended by NAMUR.

Menu texts can be switched to: German, English, French, Italian, Swedish, and Spanish.

Intuitively acquirable menu logic, based on Windows standards.

Secondary displays

2 softkeys

with context-sensitive functions.

Red LED

signals failure (On) or maintenance request/function check (flashing) according to NE 44.

Green LED

Voltage supply okay

Control panel

3 function keys

(menu, meas, enter)

and 4 arrow keys for menu selection

and data entries

5 self-sealing cable glands

M20 x 1.5

for entry of voltage supply and signal lines

Short Description: Menu Structure

Basic Functions: Calibration, Maintenance, Parameter Setting, Diagnostics

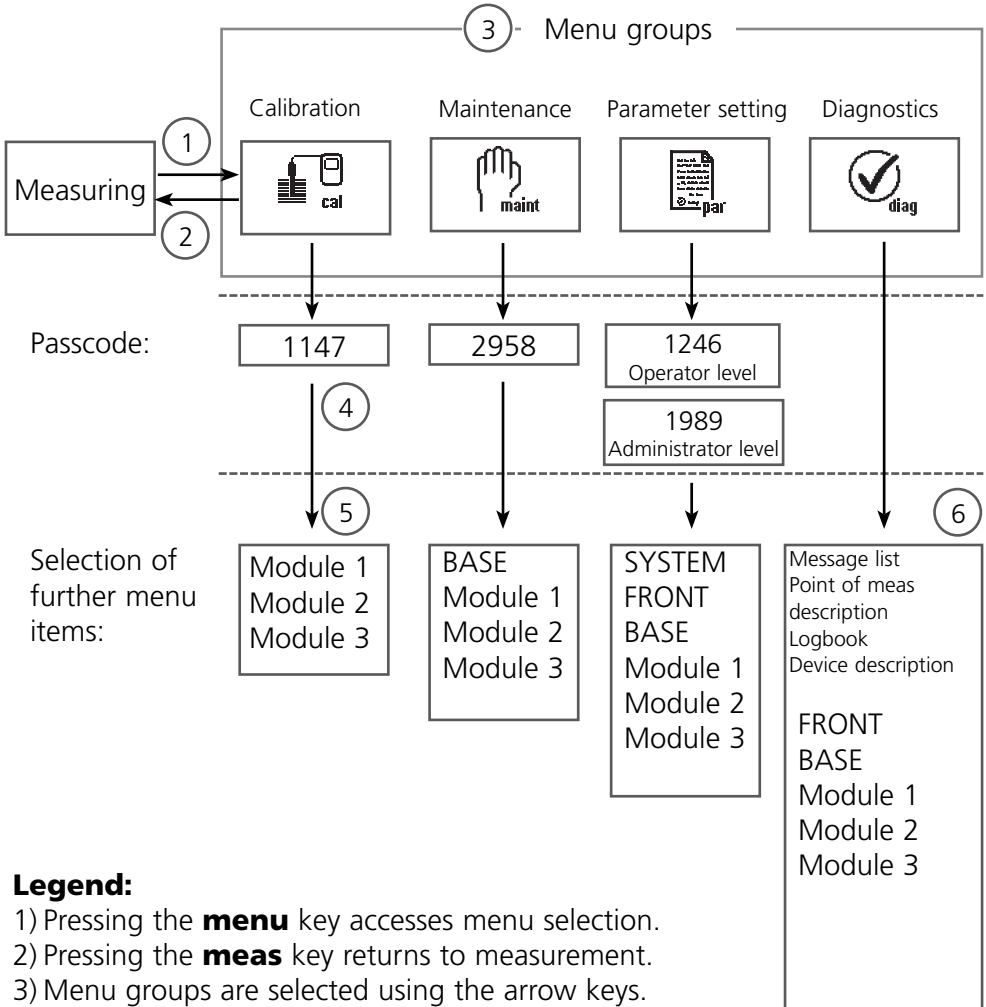

Legend:

- 1) Pressing the **menu** key accesses menu selection.
- 2) Pressing the **meas** key returns to measurement.
- 3) Menu groups are selected using the arrow keys.
- 4) Press **enter** to confirm, enter passcode.
- 5) Further menu items are displayed.
- 6) Selected functions of the Diagnostics menu can be recalled via softkey even when in measuring mode.

Short Description: FRONT Module

View into the open device (FRONT module)

Slot for SmartMedia card

- Data recording
The SmartMedia card expands the measurement recorder capacity to > 50000 records.
- Exchange of parameter sets
5 parameter sets can be stored on the SmartMedia card. The 2 internal parameter sets can be switched by remote control. Configurations can be transmitted from one analyzer to the other.
- Function expansions
are possible with additional software modules, which are released using transaction numbers (TAN)
- Software updates

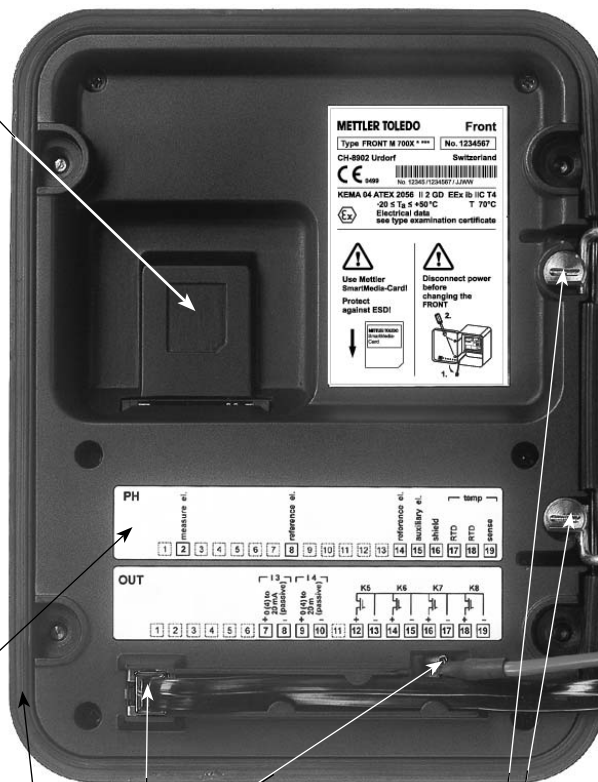

Terminal plates of "hidden" modules

Each module comes with an adhesive label containing the contact assignments. This label should be stuck to the inner side of the front (as shown). Then, the terminal assignments remain visible even if further modules are inserted.

Replacing the front module

Pull off power cord and ground wire. To separate the FRONT module from the BASE module, turn the retaining screws of the pivot hinge by 90°.

The circumferential sealing

guarantees IP 65 protection and allows spray cleaning / disinfection.

Caution! Keep clean!

Short Description: BASE Module

View into the open device (BASE module, 3 function modules installed)

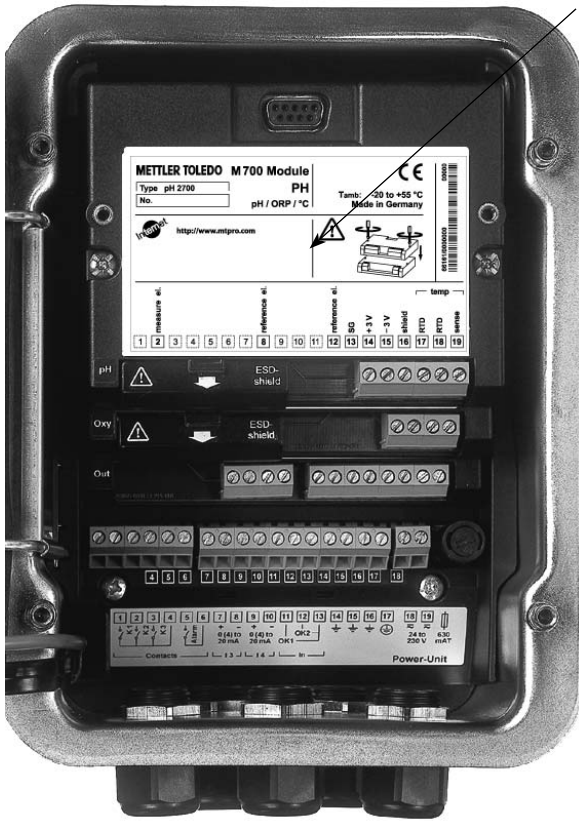

Module equipment

Module identification: Plug & Play.
Up to 3 modules can be combined as desired. Several input and communication modules are available.



Notice

Only one module can be connected in addition to a i700 module.

BASE module

2 current outputs (free assignment of process variable) and 4 relay contacts, 2 digital inputs.
VariPower broad-range power supply, 20 ... 265 V AC/DC, suitable for all public mains supplies in the world.

Power supply units, IS version:

100 ... 230 V AC or
24 V AC/DC



Warning!

Do not touch the terminal compartment, there may be dangerous contact voltages!

Important notice concerning SmartMedia card

The SmartMedia card may be inserted or replaced with the power supply switched on. Before a memory card is removed, it must be "closed" in the maintenance menu. When closing the device, make sure that the sealing is properly seated and clean.

Foundation Fieldbus (FF) Technology

Foundation Fieldbus (FF) is a digital communication system that connects different field devices over a common cable and integrates them into a control system. Its application range covers manufacturing, process, and building automation. As fieldbus standard according to EN 61158-2 (IEC 1158-2) the Foundation Fieldbus ensures the communication of different devices over one bus line.

Basic Properties

The “Data Link Layer” of the Fieldbus Foundation protocol defines 3 device types:

- The **Active Link Master** plans all activities as “Link Active Scheduler” (LAS). It controls the complete data traffic on the bus. Several Link Masters on one bus increase safety, but only one is active at a time.
- **Basic devices** are peripheral devices such as valves, drives, transmitters, or analyzers. They can react acyclically to servicing, configuration and diagnostic tasks of the master. The Link Master cyclically reads the measurement data with status.
- **Bridges** can connect a network from different bus systems.

Foundation Fieldbus (FF) Technology

Bus Communication

Foundation Fieldbus (FF) permits cyclic and acyclic services:

- **Cyclic Services - Scheduled Communication:**
are used for transmission of measurement data with status information. The Link Active Scheduler maintains a list of transmission times for all data in all devices that need to be cyclically transmitted. When it is time to transmit data, the LAS issues a "Compel Data (CD)" start signal to the respective device. Upon receipt of the "Compel Data" signal, the device broadcasts the data to all devices on the fieldbus.
- **Acyclic Services - Unscheduled Communication:**
are used for device configuration, remote maintenance, and diagnostics during operation.
All devices are given the chance to send acyclic (unscheduled) messages between transmissions of cyclic (scheduled) data. The LAS grants permission to a device to broadcast acyclic messages by issuing a "Pass Token (PT)" message. Upon receipt of the "Pass Token", the device starts data transmission.

Terminal Plate

Terminal Plate FF 700 Module:

METTLER TOLEDO M 700 Module		CE																																								
Type FF 700 X	FF	Tamb: -20 to +55 °C Made in Germany																																								
No. <input style="width: 80%;" type="text"/>	Fieldbus																																									
http://www.mt.com																																										
FF-H1 [DIN EN 61158-2]																																										
<table style="margin: auto; border-collapse: collapse;"> <tr> <td style="border: 1px dashed black; padding: 2px;">1</td><td style="border: 1px dashed black; padding: 2px;">2</td><td style="border: 1px dashed black; padding: 2px;">3</td><td style="border: 1px dashed black; padding: 2px;">4</td><td style="border: 1px dashed black; padding: 2px;">5</td><td style="border: 1px dashed black; padding: 2px;">6</td><td style="border: 1px dashed black; padding: 2px;">7</td><td style="border: 1px dashed black; padding: 2px;">8</td><td style="border: 1px dashed black; padding: 2px;">9</td><td style="border: 1px dashed black; padding: 2px;">10</td><td style="border: 1px dashed black; padding: 2px;">11</td> <td style="border: 1px dashed black; padding: 2px;">12</td> <td style="border: 1px dashed black; padding: 2px;">13</td> <td style="border: 1px dashed black; padding: 2px;">14</td> <td style="border: 1px dashed black; padding: 2px;">15</td><td style="border: 1px dashed black; padding: 2px;">16</td><td style="border: 1px dashed black; padding: 2px;">17</td><td style="border: 1px dashed black; padding: 2px;">18</td><td style="border: 1px dashed black; padding: 2px;">19</td> </tr> <tr> <td colspan="11"></td> <td style="text-align: center; padding: 2px;">A</td> <td style="text-align: center; padding: 2px;">B</td> <td style="text-align: center; padding: 2px;">shield</td> <td colspan="7"></td> </tr> </table>			1	2	3	4	5	6	7	8	9	10	11	12	13	14	15	16	17	18	19												A	B	shield							
1	2	3	4	5	6	7	8	9	10	11	12	13	14	15	16	17	18	19																								
											A	B	shield																													



Terminal Plate FF 700 X Module:

METTLER TOLEDO M 700X Module																																										
Type FF 700 X	FF	0049 Tamb: -20 to +50 °C Made in Germany/Kassel																																								
No. <input style="width: 80%;" type="text"/>	FIELDBUS																																									
<table style="width: 100%; border-collapse: collapse;"> <tr> <td style="width: 30%;"> KEMA 04 ATEX 2056</td> <td style="width: 30%;">Electr. data see type examination certificate</td> <td style="width: 40%;">CH-8902 Urdorf Switzerland</td> </tr> <tr> <td> IS, CLASS I, DIV1, GRP A, B, C, D, T4</td> <td colspan="2">Entity, T_a = 50 °C</td> </tr> <tr> <td> CLASS I, ZONE 1, AEx ib [ia], GRP IIC, T4</td> <td colspan="2">control dwg. 201.004-110</td> </tr> <tr> <td>NI, CII, DIV 2, GRP A, B, C, D</td> <td colspan="2">with IS circuits extending into DIV 1</td> </tr> <tr> <td>AIS, CI I, Zone 1, Ex ib [ia] IIC T4</td> <td colspan="2">control dwg. 201.004-120</td> </tr> <tr> <td>NI, CI I, Zone 2, Ex na [ia] IIC</td> <td colspan="2"></td> </tr> </table>			KEMA 04 ATEX 2056	Electr. data see type examination certificate	CH-8902 Urdorf Switzerland	IS, CLASS I, DIV1, GRP A, B, C, D, T4	Entity, T _a = 50 °C		CLASS I, ZONE 1, AEx ib [ia], GRP IIC, T4	control dwg. 201.004-110		NI, CII, DIV 2, GRP A, B, C, D	with IS circuits extending into DIV 1		AIS, CI I, Zone 1, Ex ib [ia] IIC T4	control dwg. 201.004-120		NI, CI I, Zone 2, Ex na [ia] IIC																								
KEMA 04 ATEX 2056	Electr. data see type examination certificate	CH-8902 Urdorf Switzerland																																								
IS, CLASS I, DIV1, GRP A, B, C, D, T4	Entity, T _a = 50 °C																																									
CLASS I, ZONE 1, AEx ib [ia], GRP IIC, T4	control dwg. 201.004-110																																									
NI, CII, DIV 2, GRP A, B, C, D	with IS circuits extending into DIV 1																																									
AIS, CI I, Zone 1, Ex ib [ia] IIC T4	control dwg. 201.004-120																																									
NI, CI I, Zone 2, Ex na [ia] IIC																																										
FF-H1 [DIN EN 61158-2]																																										
<table style="margin: auto; border-collapse: collapse;"> <tr> <td style="border: 1px dashed black; padding: 2px;">1</td><td style="border: 1px dashed black; padding: 2px;">2</td><td style="border: 1px dashed black; padding: 2px;">3</td><td style="border: 1px dashed black; padding: 2px;">4</td><td style="border: 1px dashed black; padding: 2px;">5</td><td style="border: 1px dashed black; padding: 2px;">6</td><td style="border: 1px dashed black; padding: 2px;">7</td><td style="border: 1px dashed black; padding: 2px;">8</td><td style="border: 1px dashed black; padding: 2px;">9</td><td style="border: 1px dashed black; padding: 2px;">10</td><td style="border: 1px dashed black; padding: 2px;">11</td> <td style="border: 1px dashed black; padding: 2px;">12</td> <td style="border: 1px dashed black; padding: 2px;">13</td> <td style="border: 1px dashed black; padding: 2px;">14</td> <td style="border: 1px dashed black; padding: 2px;">15</td><td style="border: 1px dashed black; padding: 2px;">16</td><td style="border: 1px dashed black; padding: 2px;">17</td><td style="border: 1px dashed black; padding: 2px;">18</td><td style="border: 1px dashed black; padding: 2px;">19</td> </tr> <tr> <td colspan="11"></td> <td style="text-align: center; padding: 2px;">A</td> <td style="text-align: center; padding: 2px;">B</td> <td style="text-align: center; padding: 2px;">shield</td> <td colspan="7"></td> </tr> </table>			1	2	3	4	5	6	7	8	9	10	11	12	13	14	15	16	17	18	19												A	B	shield							
1	2	3	4	5	6	7	8	9	10	11	12	13	14	15	16	17	18	19																								
											A	B	shield																													



Inserting the Module

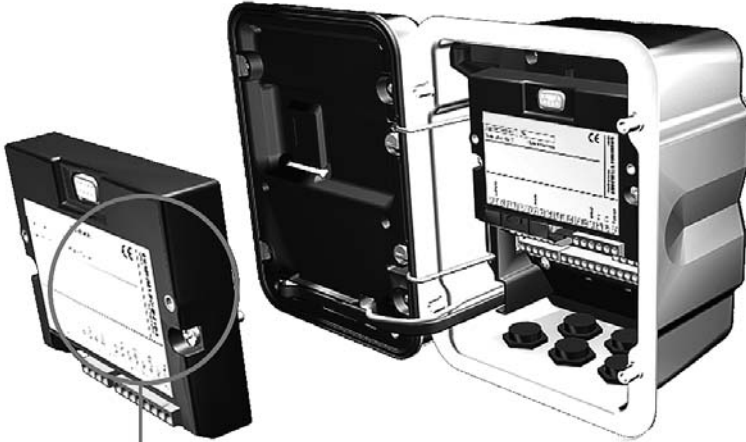

Thanks to the staggered arrangement of connectors and fastening screws the terminal strips of all modules are easy to access.

Make sure that the cable glands are tightly closed to protect against humidity.

1. Switch off power supply
2. Open the device (loosen the 4 screws at the front)
3. Place module in slot (D-SUB connector)
4. Tighten fastening screws of the module
5. Connect signal lines
6. Close device, tighten screws at the front
7. Switch on power supply
8. Assigning process variables to AI blocks on the device
9. Set parameters

Foundation Fieldbus Installation

Basic build-up of a PROFIBUS system:

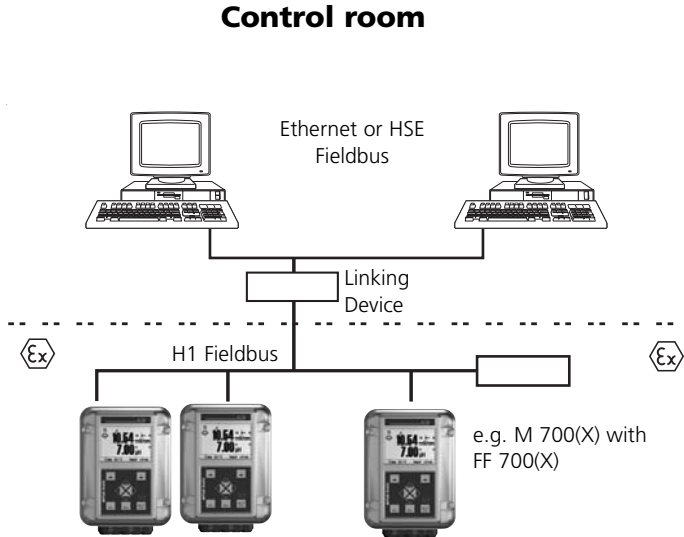

Electrical connection between module and Foundation Fieldbus is in accordance with FISCO (Fieldbus Intrinsically Safe Concept, www.fieldbus.org).

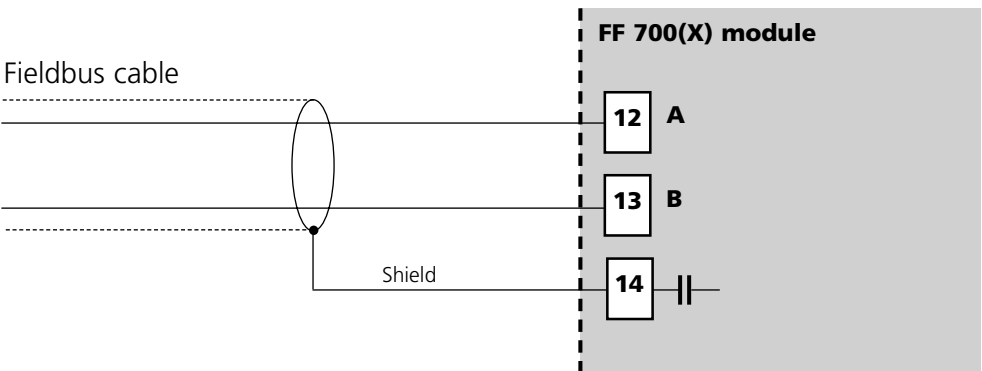

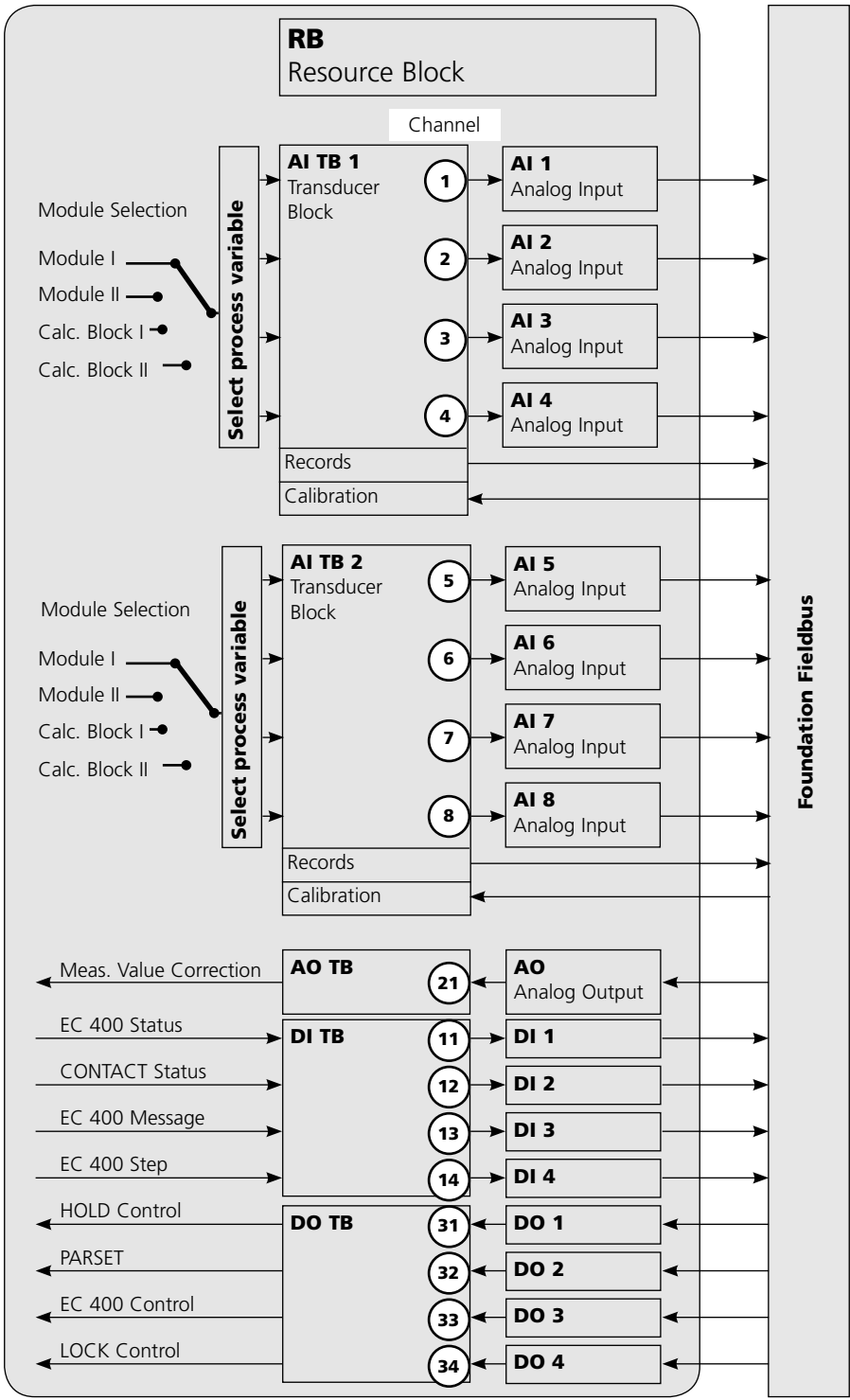

Communication Model

See diagram on previous side

All variables and parameters of the transmitter are assigned to blocks.

Resource Block (RB)

Describes the transmitter characteristics (manufacturer, device name, operating status, general status).

Analog Input Block (AI)

2 x 4 Analog Input Function Blocks provide for cyclic transmission of measured values (currently measured value with status, alarm limits, freely selectable process variable from up to 2 measuring modules).

Analog Input Transducer Block (AI TB)

Provides for acyclic data transmission. Calibration, configuration, and maintenance commands coming from the control station are processed in the Transducer Block. The sensor signal is first preprocessed in the Transducer Block. From here, the measured value is sent to the Analog Input Blocks where it can be further processed (limit values, scaling).

Connections (Channels)

The communication model shows the channel numbers for connecting the function blocks to the Transducer Blocks.



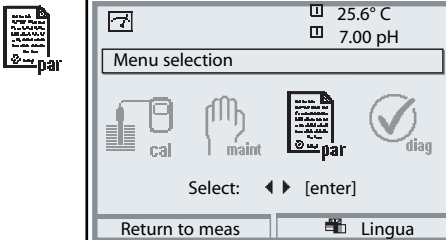

AI-TB Configuration on the Device

Assigning process variables to Analog Input Blocks on the device

Menu	Display	Assigning process variables to Analog Input Blocks
	<p>25.6 °C 7.00 pH</p> <p>Menu selection</p> <p>cal maint par diag</p> <p>Select: ◀ ▶ [enter]</p> <p>Return to meas Lingua</p>	<p>Call up parameter setting</p> <p>From the measuring mode: Press menu key to select menu. Select parameter setting using arrow keys, confirm with enter.</p>
	<p>25.6 °C 7.00 pH</p> <p>Parameter setting</p> <p>▢ Viewing level (All Data) view ▢ Operator level (Operation Data) opl ▢ Administrator (All Data) adm</p> <p>Return</p>	<p>Administrator level:</p> <p>Access to all functions, also passcode setting. Releasing or blocking a function for access from the Operator level.</p>
	<p>HOLD 25.6 °C 7.00 pH</p> <p>Parameter setting (Administrator)</p> <p>▢ System control ▢ Module FRONT ▢ Module BASE ▢ pH 2700 module ▢ Module O2 4700 ▢ Module FF 700</p> <p>Return Release</p>	<p>Select module.</p> <p>M 700 permits variable equipment with 2 measuring modules (and FF module). The available process variables are assigned via "AI-TB configuration".</p>
	<p>HOLD 25.6 °C 7.00 pH</p> <p>Module FF 700 (Administrator)</p> <p>AI-TB1 AI-TB2 Bus activation</p> <p>Return</p>	<p>Select AI-TB block:</p> <p>Assign a module to an AI-TB block. The AI-TB block includes 4 Analog Input blocks to each of which you can assign a process variable from the module.</p>

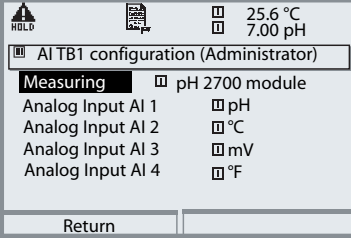
AI-TB Configuration on the Device

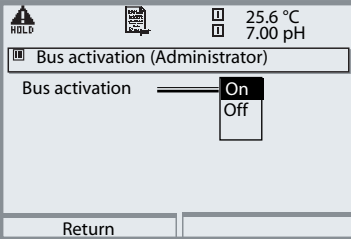
Assigning process variables to Analog Input Blocks on the device

Menu	Display	Assigning process variables to Analog Input Blocks
		<p>Select AI-TB configuration: Assign each process variable to one of the 4 Analog Input Blocks per TB. (See Page 26)</p> <p>Caution! The assignments made here also apply to the FF configuration for the connection of Analog Input Blocks to the channels of the AI Transducer Blocks! Be sure to make identical settings!</p>
Menu	Display	Bus activation
		<p>Bus activation</p> <p>On: Access control by DCS (Control system programming required by customer!)</p> <p>Off: Device access via passcode or signature (Audit Trail) as usual</p> <p>Notice:  If access control has inadvertently been activated, the device must be separated from the FF bus to make the menu accessible again.</p>

For Copy: Individual Settings

Assigning process variables to Analog Input Blocks on the device

AI Block	Process variable assigned
AI-TB1	Selected measuring module
	Analog Input Block AI 1
	Analog Input Block AI 2
	Analog Input Block AI 3
	Analog Input Block AI 4
AI-TB2	Selected measuring module
	Analog Input Block AI 5
	Analog Input Block AI 6
	Analog Input Block AI 7
	Analog Input Block AI 8

Offline Configuration

The AI blocks are divided into two groups (AI Transducer Blocks) which are each assigned to one measuring module. This allows control of functions in the measuring modules. If there is only one measuring module, both AI TBs can be assigned to the same module so that they can output more measured values cyclically. In this exemplary configuration there is a pH 2700 module in slot [I], an O2 4700 module in slot [II], and the FF 700 module in slot [III].

You can assign individual process variables from the selected measuring module to the different AI channels.

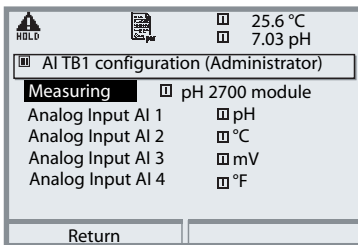

Example 1:

AI-TB1 is assigned to the pH 2700 module, therefore all process variables of the pH module are available for AI1 to AI4.

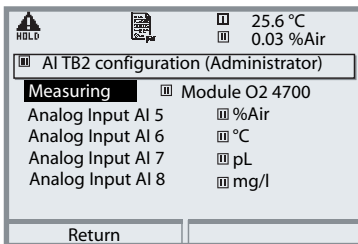

Example 2:

AI-TB1 is assigned to the O2 4700 module, therefore all process variables of the Oxy module are available for AI5 to AI8.

Bus communication on the Foundation Fieldbus can only function properly when during online configuration the blocks in the control system are set in accordance with the AI-TB configurations selected in the device configuration. The modular M 700 does not allow permanent assignment of process variables to AIs - any available module can be located in one of the three slots, which cannot be recognized from the control system.

Therefore you cannot preconfigure the device offline per DD from the control system.

AI TB 1 (AI Transducer Block)

As an example, this block was assigned to the **Module I** (measuring module, pH). All process variables available from this module can be assigned to the AI channels.

(See chapter "Process Variables Available for Fieldbus" for assignment of process variables):

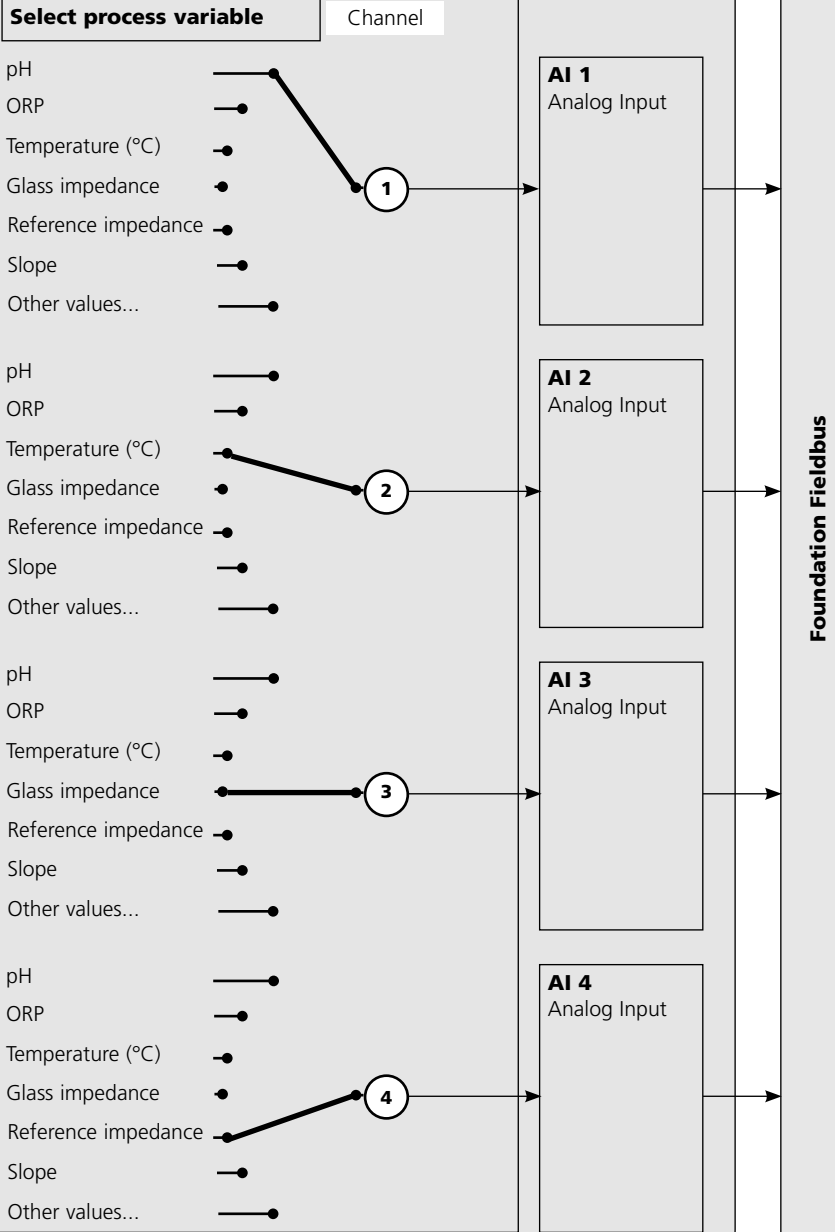

Commissioning and Configuration

Initial Commissioning

1. Supply the device with power.
2. Open the configuration program of the control system.
3. Load CFF file and DD.

After the first connection establishment, the device answers as follows:

```
Device type    FF 700_____0000000000
ID=           0001020D48_____0000000000 (e.g.)
```

4. Assign the desired name (PD_TAG) to the field device.

Setting the Resource Block (RB) parameters

5. Set the MODE_BLK. TARGET to Auto.

Setting the Analog Input Block (AI) parameters

6. Set MODE_BLK. TARGET to OOS (Out Of Service).
7. Select the desired process variable from the CHANNEL parameter (Observe parameter setting of FRONT module!).
8. Select the unit belonging to the process variable from the XD_SCALE parameter.
9. Select the unit belonging to the process variable from the OUT_SCALE parameter.
10. Set the LIN_TYPE linearization type to Direct and transmit the changes.
11. If these steps are not properly executed, the "Block Configuration Error" is generated when the block is set to "Auto".

Using the NI-FBUS Configurator from National Instruments, for example, you can graphically connect the function blocks and then load the system configuration in the device.

12. Download all data and parameters to the field device.
13. Set the target modes of all Analog Input Blocks to "Auto".

Analog Input blocks

Analog Input Blocks

The module provides 8 analog input blocks (AI 1 ... AI 8).

An Analog Input Block contains the signal processing options for the process variable supplied from the Transducer Block.

The following parameters are available:

Example:

In the M 700 AI 1 is set to pH value, AI 2 is set to temperature:

Settings in AI 1:

Parameter	Value
CHANNEL	Module 1 – Channel 1 (pH)
XD_SCALE, UNITS_INDEX	pH
OUT_SCALE, UNITS_INDEX	pH
L_TYPE	Direct
MODE_BLK, ACTUAL	Auto

Settings in AI 2:

Parameter	Value
CHANNEL	Module 1 – Channel 2 (°C)
XD_SCALE, UNITS_INDEX	°C
OUT_SCALE, UNITS_INDEX	°C
L_TYPE	Direct
MODE_BLK, ACTUAL	Auto

Caution!

When connecting the AIs to the AI TBs, you must select the process variable (measurement unit) corresponding to the measured value selected in the M 700 (see Page 22).

A faulty setting causes a Block Configuration Error in the AI function block.

Configuration of AI TB

(Example: Configuration via NI-FBUS Configurator / National Instruments)

After connection of the M 700 FF 700 module to the Foundation Fieldbus the NI-FBUS Configurator shows this block overview (default setting: Fieldbus address 22)

RESOURCE	0000001234 (RB2)
AI_TRANSDUCER_1	0000001234 (AITB)
AI_TRANSDUCER_2	0000001234 (AITB)
DI_TRANSDUCER	0000001234 (DITB)
AO_TRANSDUCER	0000001234 (AOTB)
DO_TRANSDUCER	0000001234 (DOTB)
ANALOG_INPUT_1	0000001234 (AI)
ANALOG_INPUT_2	0000001234 (AI)
ANALOG_INPUT_3	0000001234 (AI)
ANALOG_INPUT_4	0000001234 (AI)
ANALOG_INPUT_5	0000001234 (AI)
ANALOG_INPUT_6	0000001234 (AI)
ANALOG_INPUT_7	0000001234 (AI)
ANALOG_INPUT_8	0000001234 (AI)
DISCRETE_INPUT_1	0000001234 (DI)
DISCRETE_INPUT_2	0000001234 (DI)
DISCRETE_INPUT_3	0000001234 (DI)
DISCRETE_INPUT_4	0000001234 (DI)
ANALOG_OUTPUT1	0000001234 (AO)
DISCRETE_OUTPUT1	0000001234 (DO)
DISCRETE_OUTPUT2	0000001234 (DO)
DISCRETE_OUTPUT3	0000001234 (DO)
DISCRETE_OUTPUT4	0000001234 (DO)

Move all required AI blocks to the Function Block Application and start Download Configuration.



Configuration with Foundation Fieldbus

Commissioning on the Foundation Fieldbus

Only when the FF 700 module is competently configured, can the Foundation Fieldbus communication function properly. Different configuration tools from different manufacturers are available (e.g. NI-FBUS Configurator / National Instruments). They can be used to configure the device and the Foundation Fieldbus.

Notice:

Be sure to observe the operating instructions and the menu guidance of the control system or the configuration tool during installation and configuration via the control system.

Installing the DD (Device Description):

During initial installation the device description (*.cff, *.sym and *.ffo) must be installed in the control system .

For network projecting, you require the CFF file (Common File Format).

These files can be obtained from:

- the included CD
- internet: www.mt.com/pro
- Foundation Fieldbus: www.fieldbus.org.

Identifying the Transmitter

There are several possibilities to identify a FF transmitter in the network. The most important one is the "Device Identifier" or DEV_ID. It consists of the manufacturer ID, device type, and serial number of the transmitter.

Commissioning and Configuration

Corresponding to example given on Page 25, "Offline Configuration"

For parameter changes, you must set MODE_BLK/TARGET to OOS (Out of Service) since otherwise the error message NIF_ERR_WRONG_MODE_FOR_REQUEST would appear for [Write Changes].

Analog Input 1

"Process" card:	CHANNEL	Module 1 - Channel 1
"Scaling" card:	XD_SCALE/UNITS_INDEX	pH
	OUT_SCALE/UNITS_INDEX	pH
	L_TYPE	Direct
Button	[Write Changes]	
Button	[Auto]	

Analog Input 2

"Process" card:	CHANNEL	Module 1 - Channel 2
"Scaling" card:	XD_SCALE/UNITS_INDEX	°C
	OUT_SCALE/UNITS_INDEX	°C
	L_TYPE	Direct
Button	[Write Changes]	
Button	[Auto]	

Analog Input 3

"Process" card:	CHANNEL	Module 1 - Channel 3
"Scaling" card:	XD_SCALE/UNITS_INDEX	mV
	OUT_SCALE/UNITS_INDEX	mV
	L_TYPE	Direct
Button	[Write Changes]	
Button	[Auto]	

Analog Input 4

"Process" card:	CHANNEL	Module 1 - Channel 4
"Scaling" card:	XD_SCALE/UNITS_INDEX	Mohm
	OUT_SCALE/UNITS_INDEX	Mohm
	L_TYPE	Direct
Button	[Write Changes]	
Button	[Auto]	

Commissioning and Configuration

Analog_Input_5

"Process" card:	CHANNEL	Module 2 - Channel 1
"Scaling" card:	XD_SCALE/UNITS_INDEX	%
	OUT_SCALE/UNITS_INDEX	%
	L_TYPE	Direct
Button	[Write Changes]	
Button	[Auto]	

Analog_Input_6

"Process" card:	CHANNEL	Module 2 - Channel 2
"Scaling" card:	XD_SCALE/UNITS_INDEX	°C
	OUT_SCALE/UNITS_INDEX	°C
	L_TYPE	Direct
Button	[Write Changes]	
Button	[Auto]	

Analog_Input_7

"Process" card:	CHANNEL	Module 2 - Channel 3
"Scaling" card:	XD_SCALE/UNITS_INDEX	mbar
	OUT_SCALE/UNITS_INDEX	mbar
	L_TYPE	Direct
Button	[Write Changes]	
Button	[Auto]	

Analog_Input_8

"Process" card:	CHANNEL	Module 2 - Channel 4
"Scaling" card:	XD_SCALE/UNITS_INDEX	g/l
	OUT_SCALE/UNITS_INDEX	g/l
	L_TYPE	Direct
Button	[Write Changes]	
Button	[Auto]	

Commissioning and Configuration

An external pressure sensor can be connected to the Analog Output Block (AO) through the Foundation Fieldbus network.

Analog_Output1

"Process" card:	CHANNEL	Channel 21 (Analog Output Value)
"Scaling" card:	XD_SCALE/EU_100	9999
	XD_SCALE/UNITS_INDEX	mbar
	OUT_SCALE/EU_100	9999
	OUT_SCALE/UNITS_INDEX	mbar
"Limits" card	SP_HI_LIM	9999
Button	[Write Changes]	
Button	[Cascade]	

Parameter	Value
MODE_BLK	Cas Auto
TARGET	Cas
ACTUAL	RCas Cas Auto Man OOS
PERMITTED	Cas Auto
NORMAL	Cas Auto
PV	1021.77
VALUE	1021.77
STATUS	Good_Cascade NonSpecific NotLimited
QUALITY	Good_Cascade
SUBSTATUS	NonSpecific
LIMITS	NotLimited
SP	1021.77
VALUE	1021.77
STATUS	Good_Cascade NonSpecific NotLimited
QUALITY	Good_Cascade
SUBSTATUS	NonSpecific
LIMITS	NotLimited
OUT	1021.77
VALUE	1021.77
STATUS	Good_NonCascade NonSpecific NotLimited
QUALITY	Good_NonCascade
SUBSTATUS	NonSpecific
LIMITS	NotLimited
CAS_IN	1021.85
VALUE	1021.85
STATUS	Good_NonCascade NonSpecific NotLimited
QUALITY	Good_NonCascade
SUBSTATUS	NonSpecific
LIMITS	NotLimited
CHANNEL	Channel 21 - Analog Output Value

Then the AO Block should be in ACTUAL Mode Cas.

The coupled output value (AI) from the linked pressure transmitter appears at input CAS_IN.

In Cascade mode the measured OUT value is passed to the transmitter and is available to the system.

The parameter settings required for the DI and DO blocks are given on the following page.

Commissioning and Configuration

Discrete_Input_1

"Process" card:	CHANNEL	Channel 11	Discrete Input Value
Button	[Write Changes]		
Button	[Auto]		

Discrete_Input_2

"Process" card:	CHANNEL	Channel 12	Discrete Input Value
Button	[Write Changes]		
Button	[Auto]		

Discrete_Input_3

"Process" card:	CHANNEL	Channel 13	Discrete Input Value
Button	[Write Changes]		
Button	[Auto]		

Discrete_Input_4

"Process" card:	CHANNEL	Channel 14	Discrete Input Value
Button	[Write Changes]		
Button	[Auto]		

Discrete_Output1

"Process" card:	CHANNEL	Channel 31	Discrete Output Value
Button	[Write Changes]		
Button	[Auto]		

Discrete_Output2

"Process" card:	CHANNEL	Channel 32	Discrete Output Value
Button	[Write Changes]		
Button	[Auto]		

Discrete_Output3

"Process" card:	CHANNEL	Channel 33	Discrete Output Value
Button	[Write Changes]		
Button	[Auto]		

Discrete_Output4

"Process" card:	CHANNEL	Channel 34	Discrete Output Value
Button	[Write Changes]		
Button	[Auto]		

Commissioning and Configuration

Calibration Protocols

Calibration Protocols

The protocols are transmitted in the AI TBs in binary form. The DD provides a method for converting them to a readable format. The method can be started with "Read protocol" in the "Protocol" menu of the AI TB.

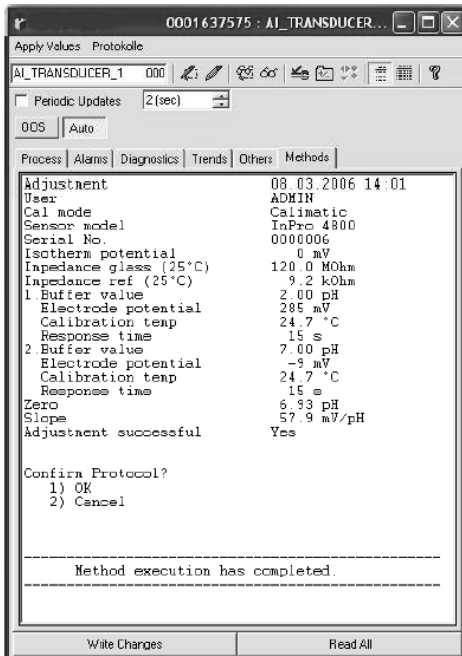
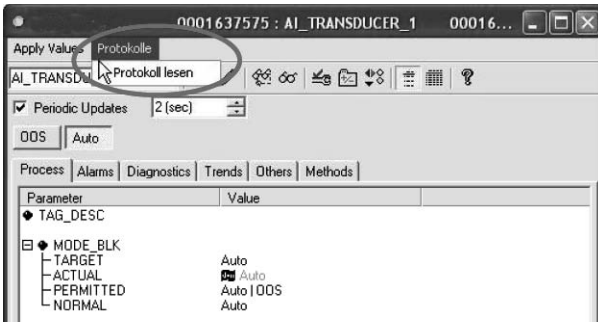

Each AI TB of the FF module has a ring buffer which can store up to three protocols. A fourth protocol would overwrite the first protocol in that TB.

With "Read protocol", the calibration protocol of the respective module can be read out from the AI TB. The example shows the pH protocol of AI TB1. At the end of the method you can confirm the protocol (OK) and thus delete it from the ring buffer. After confirmation you will be informed if further data, i.e. another protocol, are available. Without confirmation (Cancel), you can re-read the protocol as often as you like.

Parameters of AI Transducer Blocks

All blocks correspond to the "FF-007-5.0 Specifications". Only the two AI-TB blocks have been extended (Index 14 ... 39). AI TB1 and AI TB2 can be assigned to different measuring modules in the M 700.

Index	Parameter	Description
Standard parameters		
0	AITB	
1	ST_REV	
2	TAG_DESC	
3	STRATEGY	
4	ALERT_KEY	
5	MODE_BLK	
6	BLOCK_ERR	
7	UPDATE_EVT	
8	BLOCK_ALM	
9	TRANSDUCER_DIRECTORY	
10	TRANSDUCER_TYPE	
11	XD_ERROR	
12	COLLECTION_DIRECTORY	
13	PRIMARY_VALUE	Measured value channel 1
Manufacturer-specific extensions: Measured values		
14	SECONDARY_VALUE	Measured value channel 2
15	THIRD_VALUE	Measured value channel 3
16	FOURTH_VALUE	Measured value channel 4
Manufacturer-specific extensions: Product calibration		
17	CAL_SAMPLE_PRD	Starts the first part of product calibration
18	CAL_SAMPLE_PRD_STORED_VAL	Shows the value stored during the first part of product calibration
19	CAL_PRODUCT	Sets the value for the second part of product calibration
20	CAL_MODE_PRD	"Mode of ... calibration"
21	CAL_RESULT	Result of calibration

Parameters of AI Transducer Blocks

Index	Parameter	Description
Manufacturer-specific extensions: Protocols		
22	PROTOCOL_STATUS	Status
23	PROTOCOL_DATA_0	Binary protocol data, part 1
24	PROTOCOL_DATA_1	
25	PROTOCOL_DATA_2	
26	PROTOCOL_DATA_3	
27	PROTOCOL_DATA_4	
28	PROTOCOL_DATA_5	
29	PROTOCOL_DATA_6	
30	PROTOCOL_DATA_7	
31	PROTOCOL_DATA_8	
32	PROTOCOL_DATA_9	
33	PROTOCOL_DATA_A	
34	PROTOCOL_DATA_B	
35	PROTOCOL_DATA_C	
36	PROTOCOL_DATA_D	
37	PROTOCOL_DATA_E	
38	PROTOCOL_DATA_F	Binary protocol data, part 16
39	PROTOCOL_CONFIRM	Save protocol

A ring buffer for up to 3 protocols is implemented in the module. The DD includes a method for presenting the protocol in a readable manner. This method is called up in the "Protocol" menu of the AI TB Block.

Function Block AO

Cyclic transmission of an external correction value (e.g. pressure correction for O2 4700).

DI Function Blocks

DI 1: EC 400 Status

Bit								Meaning
7	6	5	4	3	2	1	0	
							1	Probe in MEASURE position (PROCESS)
						1		Probe in SERVICE position
					1			Service switch actuated
				1				EC 400 alarm
			1					EC 400 program running
0	0	0						No program
0	0	1						Program: Cleaning
0	1	0						Program: Cal 2point
0	1	1						Program: Cal 1point
1	0	0						Program: Parking
1	0	1						Program: USER 1
1	1	0						Program: USER 2
1	1	1						Program: Service

DI 2: CONTACTS / LOCK Status / ENABLE Request

Bit								Meaning
7	6	5	4	3	2	1	0	
							1	Contact K4 active
						1		Contact K3 active
					1			Contact K2 active
				1				Contact K1 active
			1					CAL terminates AI-TB1 (1 min or until cal record collected)
		1						CAL terminates AI-TB2 (1 min or until cal record collected)
0	0							Measuring mode
0	1							Unconfirmed enable request
1	0							Confirmed enable request
1	1							Enable

DI Function Block EC 400 Messages

DI 3: EC 400 Messages

Bit								Meaning
7	6	5	4	3	2	1	0	
							1	Probe maintenance request
						1		Media adapter maintenance request
					1			EC 400 basic device maintenance request
			1					Medium maintenance request
		1						Probe failure
	1							Media adapter failure
		1						EC 400 basic device failure
1								Calibration / Communication error

Explanation of EC 400 Messages: Maintenance request

Probe maintenance request

U 231	Probe move time MEASURE (PROCESS)
U 234	Probe move time SERVICE
U 232	Probe wear counter
U 228	Probe cylinder untight

Media adapter maintenance request

U 190	Buffer I almost empty
U 191	Buffer II almost empty
U 192	Cleaner almost empty

Maintenance request / EC 400 basic device

U 233	Water pressure switch
U 229	Sensor dismount guard defective
U 235	Safety valve defective

Medium maintenance request

U 241	Check water
U 242	Check buffer I
U 243	Check buffer II
U 244	Check cleaner
U 245	Check aux. valve I
U 246	Check aux. valve II

EC 400 Messages, EC 400 Step

Explanation of EC 400 Messages: Failure

Probe failure	
U 230	Probe limit position MEASURE (PROCESS)
U 227	Probe limit position SERVICE
Media adapter failure	
U 194	Buffer I empty
U 195	Buffer II empty
U 196	Cleaner empty
EC 400 basic device failure	
U 220	Compressed air switch
U 225	Probe valve defective
U 224	EC 400 flooded
U 221	Sensor dismantled
Calibration / Communication error	
U 251	Calibration error

DI 4: EC 400 Step

Bit								Meaning	
7	6	5	4	3	2	1	0		
							1	System in SINGLE_STEP	
		X	X	X	X	X		Step 1 ... 30	
	0								Reserved
0									Reserved

The half-automated EC 400 program control in Single-Step Mode can only be activated and triggered from the M 700. Control via bus is not possible, however the Single-Step Mode can be watched.

DO Function Blocks

DO 1: HOLD Control

Bit								Meaning
7	6	5	4	3	2	1	0	
							1	System HOLD
						0		Reserved
					0			Reserved
				0				Reserved
			0					Reserved
		0						Reserved
	0							Reserved
0								Reserved

DO 2: PARSET

Bit								Meaning
7	6	5	4	3	2	1	0	
							1	Parameter set B (internal)
					0	0	0	Parameter set not from card
					0	0	1	Parameter set 1 (card)
					0	1	0	Parameter set 2 (card)
					0	1	1	Parameter set 3 (card)
					1	0	0	Parameter set 4 (card)
					1	0	1	Parameter set 5 (card)
			0					Reserved
		0						Reserved
	0							Reserved
0								Reserved

DO Function Blocks

DO 3: EC 400 Control

Bit								Meaning
7	6	5	4	3	2	1	0	
							X	Reserved
						1		Probe in SERVICE position (MEASURE = 0)
						1		Manual, Time control Off (Auto, Time control On = 1)
				X				Reserved
			X					Reserved
0	0	0						No program start
0	0	1						Program: Cleaning
0	1	0						Program: Cal 2point
0	1	1						Program: Cal 1point
1	0	0						Program: Parking
1	0	1						Program: USER 1
1	1	0						Program: USER 2
1	1	1						No program start

DO 4: LOCK Control

Bit								Meaning
7	6	5	4	3	2	1	0	
						0	0	Measuring mode
						0	1	Enabled
						1	0	Busy
						1	1	Not used
					X			Reserved
				X				Reserved
			X					Reserved
		X						Reserved
	X							Reserved
X								Reserved

Enable / Lock via DCS

Caution: Control system programming required by customer!

Enable / Lock M 700 for on-site calibration via DCS.

The DI 1 and DO 4 function blocks are used for communicating with the DCS (control system programming required by customer).

Step 1: The user calls up the cal menu, for example, on the device. An "Enable request running ..." window appears instead of the passcode prompt. An enable request message is sent to the DCS.

Step 2: The DCS confirms the request, still without a decision. Now, a message window opens on the control system where the plant operator selects the decision Yes/No. Until a decision is made, the display reads "Wait for enable signal from DCS ..."

Step 3: The decision has been made:

YES: The window disappears and the user is prompted to enter the passcode (or signature for AuditTrail). Now, he may use the menu.

NO: A "Request denied!" window appears and the device returns to measuring mode.

Step 4: After the menu system has been exited, the DCS receives a message that manual operation is terminated. This erases the authorization.

Menu Selection

After switching on, the analyzer performs an internal test routine and automatically detects the number and type of modules installed. Then, the analyzer goes to measuring mode.

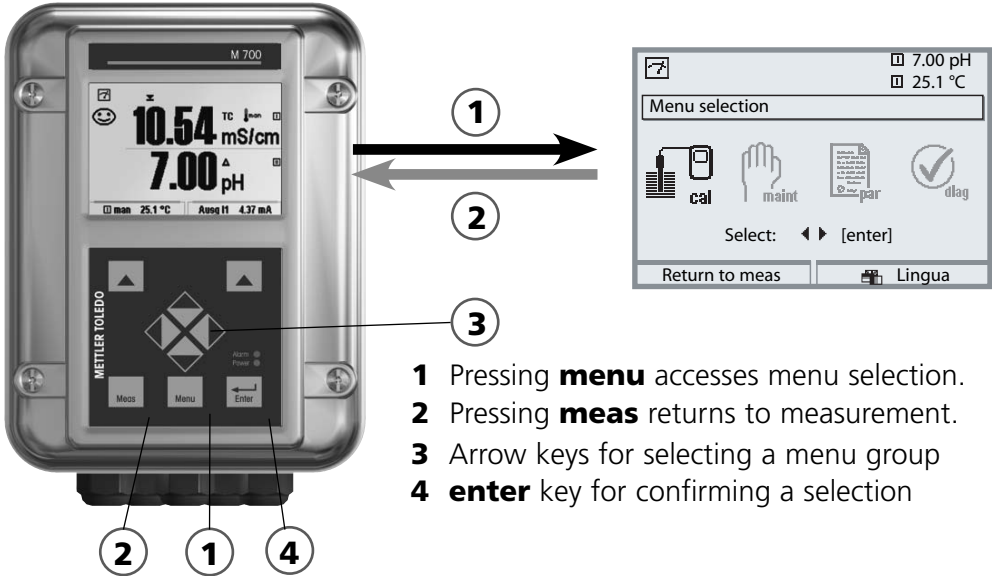

Menu Structure

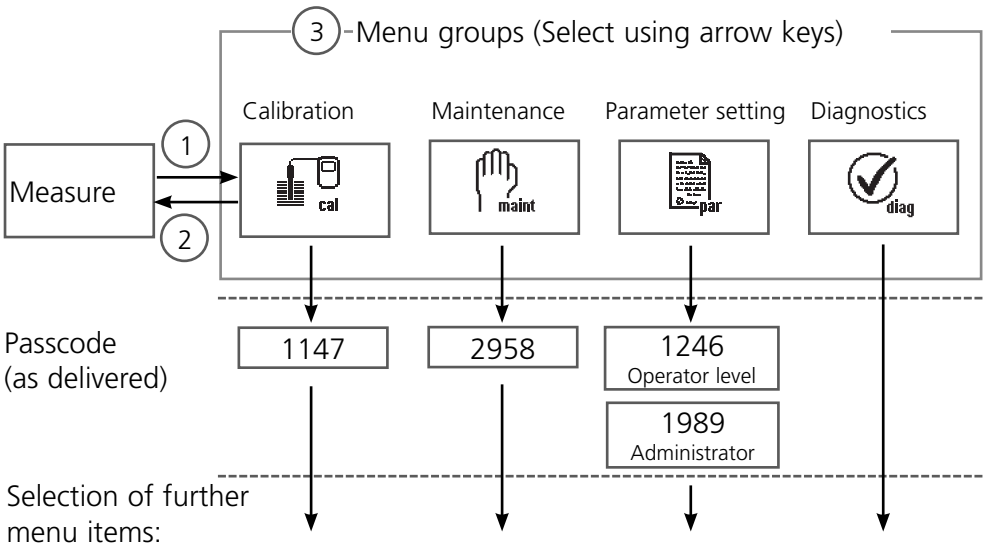

Passcode Entry

To enter a passcode:

Select the position using the left/right keys, then edit the number using the up/down keys. When all numbers have been entered, confirm with **enter**.

To change a passcode

- Open the menu selection (**menu**)
- Select parameter setting
- Administrator level, enter passcode
- Select System control: Passcode entry

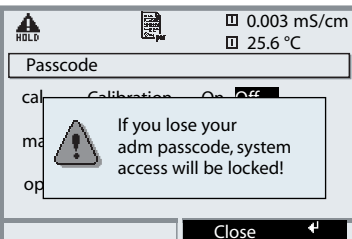
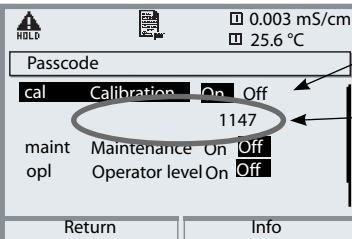
Menu	Display	System control: Passcode entry												
		<p>Changing a passcode: "Passcode entry" menu</p> <p>When this menu is opened, the analyzer displays a warning (Fig.). Passcodes (factory settings):</p> <table><tr><td>Calibration</td><td>(cal)</td><td>1147</td></tr><tr><td>Maintenance</td><td>(maint)</td><td>2958</td></tr><tr><td>Operator level</td><td>(opl)</td><td>1246</td></tr><tr><td>Administrator level</td><td>(adm)</td><td>1989</td></tr></table> <p>Caution</p> <p>If you lose the Administrator passcode, system access is locked! Please consult our technical support!</p>	Calibration	(cal)	1147	Maintenance	(maint)	2958	Operator level	(opl)	1246	Administrator level	(adm)	1989
Calibration	(cal)	1147												
Maintenance	(maint)	2958												
Operator level	(opl)	1246												
Administrator level	(adm)	1989												
		<p>To change a passcode, select "On" using the arrow keys. Confirm with enter.</p> <p>Select the position using the left/right keys, then edit the number using the up/down keys. When all numbers have been entered, confirm with enter.</p>												

Function Control Matrix

Controlling parameter set selection / KI recorder via Fieldbus H1

Parameter setting/Administrator level/System control/Function control matrix

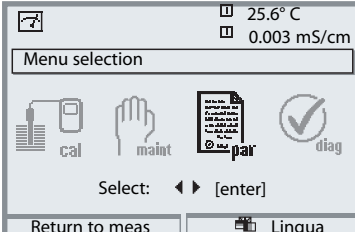
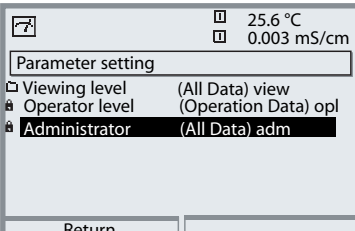
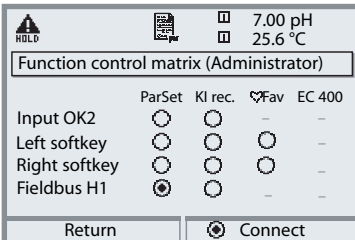
Menu	Display	Control via Foundation Fieldbus
		<p>Call up parameter setting</p> <p>From the measuring mode: Press menu key to select menu. Select parameter setting using arrow keys, confirm with enter.</p>
		<p>Administrator level:</p> <p>Access to all functions, also passcode setting. Releasing or blocking a function for access from the Operator level.</p> <p>At the Administrator level: Select "System control", then "Function control matrix".</p>
		<p>Function control matrix</p> <p>Clear assignment: control element/function. Example: Fieldbus H1 controls the parameter set selection.</p>
		

Specifications

Specifications M 700 FF 700(X)

Foundation Fieldbus FF-H1 (Ex ia IIC)	Digital communication in hazardous areas via current modulation
Physical interface	According to IEC 61158-2
Transfer rate	31.25 kbits/s
Communication protocol	FF-816
Profile	FF_H1 (Foundation Fieldbus)
Bus address	Visible on the device but not adjustable
Supply voltage (FISCO)	Bus supply: 9 ... 17.5 V Linear barrier: 9 ... 24 V
Current consumption	< 12 mA
Max. current in case of fault (FDE)	< 17 mA
FF communication model 1 Physical Block 5 transducer blocks 8 AI Function blocks 4 DI function blocks 4 DO Function blocks 1 AO function block	Certified to ITK 4.6 Device description Connection to signal processing Output of measured values with status via the Fieldbus Output of messages with status via the Fieldbus Control via the Fieldbus for analog compensation signals (e.g. O ₂ process pressure)

Specifications

General Data

Explosion protection

(IS module only)

ATEX: See rating plate: KEMA 03 ATEX 2056
II 2 (1) GD EEx ib [ia] IIC T4 T 70 °C

FM: NI, Class I, Div 2, GP A, B, C, D T4
with IS circuits extending into Division 1
Class I, Zone 2, AEx nA, Group IIC, T4
Class I, Zone 1, AEx me ib [ia] IIC, T4

CSA: NI, Class I, Div 2, Group A, B, C, D
with IS circuits extending into Division 1
AIS, Class I, Zone 1, Ex ib [ia] IIC, T4
NI, Class I, Zone 2, Ex nA [ia] IIC

EMC

Emitted interference
Immunity to interference

NAMUR NE 21 and
EN 61326 VDE 0843 Part 20 /01.98
EN 61326/A1 VDE 0843 Part 20/A1 /05.99
Class B
Industry

Lightning protection

EN 61000-4-5, Installation Class 2

Nominal operating conditions

Ambient temperature:
-20 ... +55 °C (Ex: max. +50 °C)
Rel. humidity: 10 ... 95 % not condensing

Transport/Storage temperature

-20 ... +70 °C

Screw clamp connector

Single wires and flexible leads up to 2.5 mm²

Process Variables (Fieldbus)

Process variables which can be assigned to Analog Input Blocks (AI):

Module Types pH: pH 2700(X)
 pH 2700i(X)
 EC 700(X)

Measured value	Unit of measure
pH value	pH
Electrode voltage	mV
Electrode potential (ORP)	mV
rH value	rH
Glass impedance	Ohm
Reference impedance	Ohm
Temperature	°C
Temperature	°F
pH zero point	pH
pH slope	mV/pH

Calculation Block pH / pH

Measured value	Unit of measure
Delta pH value	pH
Delta ORP	mV
Delta temperature	°C

Process Variables (Fieldbus)

Process variables which can be assigned to Analog Input Blocks (AI):

Module Types O₂:	O2 4700(X) O2 4700i(X)	O2 4700(X) ppb O2 4700i(X) ppb
Measured value	Unit of measure	
Saturation (Air)	%	
Saturation (O ₂)	%	
Concentration	mg/l	
Concentration	ppm	
Volume concentration (GAS)	%	
Volume concentration (GAS)	ppm	
Sensor current	nA	
Temperature	°C	
Temperature	°F	
Air pressure	mbar	
DO partial pressure	mbar	
Zero	nA	
Slope	nA/mbar	
Current input	mA	

Calculation Block O₂ / O₂

Measured value	Unit of measure
Delta saturation (Air)	%
Delta saturation (O ₂)	%
Delta temperature	°C
Delta O ₂ concentration	mg/l
Delta O ₂ concentration	ppm
Delta volume conc. (gas)	%
Delta volume conc. (gas)	ppm

Process Variables (Fieldbus)

Process variables which can be assigned to Analog Input Blocks (AI):

Module Types Cond: Cond 7700(X)

Measured value	Unit of measure
Conductivity	$\mu\text{S/cm}$
Resistivity	Ohm/cm
Concentration	%
Concentration	g/kg
Temperature	$^{\circ}\text{C}$
Temperature	$^{\circ}\text{F}$
cell constant	cm^{-1}
USP value	%

Calculation Block Cond / Cond

Measured value	Unit of measure
Delta conductivity	$\mu\text{S/cm}$
Delta resistivity	Ohm/cm
Delta temperature	$^{\circ}\text{C}$
Ratio	
Passage	%
Rejection	%
Deviation	%
pH value	pH

Process Variables (Fieldbus)

Process variables which can be assigned to Analog Input Blocks (AI):

Module Types Cond Ind: Cond Ind 7700(X)

Measured value	Unit of measure
Conductivity	$\mu\text{S}/\text{cm}$
Resistivity	Ohm/cm
Concentration	%
Concentration	g/kg
Temperature	$^{\circ}\text{C}$
Temperature	$^{\circ}\text{F}$
Zero	S/cm
Cell factor	(value only)

Calculation Block Cond Ind / Cond Ind

Measured value	Unit of measure
Delta conductivity	$\mu\text{S}/\text{cm}$
Delta resistivity	Ohm/cm
Delta temperature	$^{\circ}\text{C}$
Ratio	
Passage	%
Rejection	%
Deviation	%

Process Variables (Fieldbus)

Process variables which can be assigned to Analog Input Blocks (AI):

Module Types CO₂: CO₂ 5700i

Measured value	Unit of measure
Saturation	%
Concentration	mg/l
Temperature	°C
Partial pressure	p'
Glass impedance	Mohm
Reference impedance	kohm
Temperature	°F
Zero	pH
Slope	mV/pH

Calculation Block pH / pH

Measured value	Unit of measure
Delta saturation	%
Delta concentration	mg/l
Delta temperature	°C

Index

FF 700(X) Module

Access control by DCS 23
Active Link Master 14
AI Transducer Blocks, parameters 36
Analog Input Block (AI) 21
Analog Input blocks 28
Analog Input Transducer Block (AI TB) 21
AO Function Block 37
Application in hazardous locations 7
Assigning process variables to Analog Input Blocks 22, 23
Assigning process variables to Analog Input Blocks on the device 22, 23, 24
Audit Trail Log 6

B

BASE module 13
Basic devices 14
Bridges 14
Bus activation 23
Bus communication 15

C

Cable glands 10
Channel 20, 26
Commissioning on the Foundation Fieldbus 30
Communication Model 20, 21
Compel Data (CD) 15
Configuration with Foundation Fieldbus 30
Connections (Channels) 21
CONTACTS 38
Control via Foundation Fieldbus 46
Cyclic services 15

D

Data Link Layer 14
Device Description 30

Index

FF 700(X) Module

Device software 8
DI Function Blocks 38
Disposal 2
DO Function Blocks 41

E
EC 400 Control 42
EC 400 messages 40
EC 400 status 38
Electrical connection between module and Foundation Fieldbus 19
Electronic Signature 6
EMC 48
Enable / Lock via DCS 43
ENABLE request 38

F
FDA 21 CFR Part 11 6
Fieldbus, available process variables 49
Fieldbus cable 19
FISCO 19
Foundation Fieldbus (FF) Technology 14
FRONT module 12
Function control matrix 46

G
Graphic display 10

H
Hardware and software version 8
HOLD Control 41

I
Identifying the Transmitter 30
Installation 19
Intended use 6

Index

FF 700(X) Module

L

LAS 15

LED 10

LOCK Control 42

Locking (via DCS) 43

LOCK status 38

M

Menu selection 44

Menu structure 11, 44

Mise en place du module 17

Modular concept 9

Module equipment 13

Modules 12

Module software 8

P

Parameters of AI Transducer Blocks 36

PARSET 41

Passcode entry 45

Passcode lost 45

Pass Token (PT) 15

Process values, assignment to Analog Input Blocks (AI) 53

Q

Query actual device/module software 8

R

Replacing the front module 12

Return of products 2

S

Safety information 7

Scheduled Communication 15

Screw clamp connector 48

Sealing 12

Index

FF 700(X) Module

Secondary displays 10
Select AI-TB configuration 22, 23
Select AI configuration 22, 23
Serial number 8
Short description 10
Slot for SmartMedia card 12
SmartMedia card 12
Softkeys 10
Softwareversion 8
Specifications 47, 48
Standard Resource Block (RB) 21

T

Terminal compartment 13
Terminal plate 12, 16
Trademarks 2

U

Unscheduled Communication 15

W

Warranty 2

BR **Mettler-Toledo Ind. e Com. Ltda.,**
Alameda Araguaia, 451 - Alphaville
BR - 06455-000 Barueri / SP, Brazil
Phone +55 11 4166 74 00
Fax +55 11 4166 74 01

CH **Mettler-Toledo (Schweiz) AG,**
Im Langacher,
CH - 8606 Greifensee, Switzerland
Phone +41 44 944 45 45
Fax +41 44 944 45 10

D **Mettler-Toledo GmbH,** Prozeßanalytik,
Ockerweg 3,
D - 35396 Gießen, Germany
Phone +49 641 507-333
Fax +49 641 507-397

F **Mettler-Toledo Analyse Industrielle Sàrl,**
30 Bld. de Douaumont, BP 949,
F - 75829 Paris Cedex 17, France
Phone +33 1 47 37 06 00
Fax +33 1 47 37 46 26

USA **Mettler-Toledo Ingold, Inc.,**
36 Middlesex Turnpike,
USA - Bedford, MA 01730, USA
Phone +1 781 301-88 00
Fax +1 781 271-06 81



Management-System
zertifiziert nach
ISO 9001 / ISO 14001



www.mtpro.com